



**RTD sensor with
miniature connection head**

TM 50 / TMD 50

- Temperature sensor with stainless steel sheath, with or without compression fitting.
- Measuring range **from -80°C to +400°C** (PT100 and PT1000).
from -20°C to +120°C (NTC).
- Mounting of wires : **single pair** (2, 3 or 4 wires).
multipair (4 or 6 wires).
- For other resistor types PT25, PT50, PT500, PT200 or NI, please contact us.

Part numbers

To order, just add the codes to complete the part number.

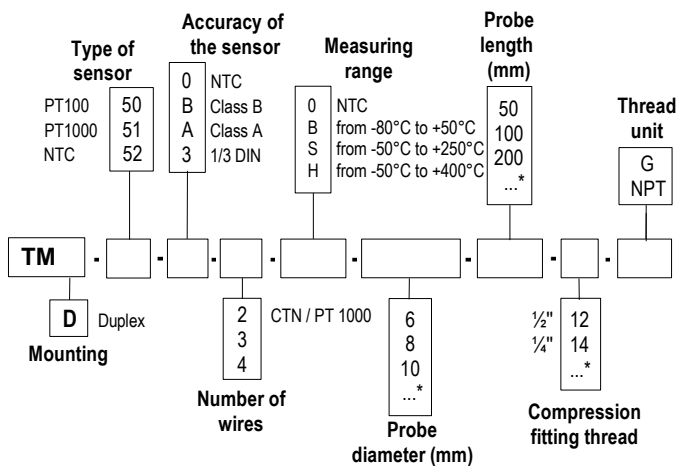

* Other dimensions on request

Example : TM-50-B-3-S-6-100-12G.

Model : Temperature sensor PT 100 class B, with 3 wires in a sheath of 6 mm diameter and 100 mm length, and with a 1/2"G thread plug. Measuring range from -50°C to 250°C.

Dimensions

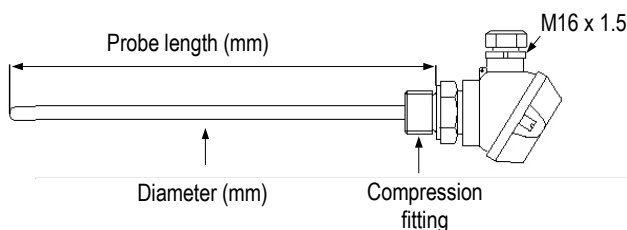

Technical features

- Measuring range**.....from -80°C to +400°C (PT100 and PT1000)
from -20°C to +120°C (NTC)
- Accuracy***.....**PT100 or PT1000** : see "Tolerances" table
NTC : see "Tolerances" table
- Type of sensor**.....**PT100 or PT1000** : Class B, Class A,
1/3 DIN as per DIN IEC751
NTC : resistance at 25°C, R₂₅ = 10KΩ
Nominal Beta B25/85 value = 3.695K ±1%

Mounting of wires.....**single pair 2, 3 or 4 wires**
For T>250°C do not use 4 wires in a sheath of 6mm Ø.
multipair 4 wires only
For T>250°C use sheath from 8mm Ø.



- Storage temperature**.....from -20°C to +80°C
- Sheath**.....316 L stainless steel, 3/4 to 4/4 hard,
no welding
- Compression fitting**.....316 L stainless steel
- Thread**.....with or without, 1/4, 1/2, Gaz or NPT plug
(other thread on request)
- Electrical connection**.....with or without terminal block
transmitter 4/20mA 0/10V as option
- Connection head**.....Aluminium alloy
cable gland : M16 x 1.5
IP65 protection
- Adjustable mountings**.....compression fitting welded further along the
sheath, flange, clamp, replacable probe
insert, restricted end, ambient end.
See datasheet.

Useful information on thermometry with platinum resistor PT100, PT1000 or NTC .

• 2-wire connection

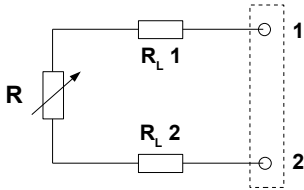

This is the simplest way, but line resistors (RL1 and RL2) are connected to the sensor in a series circuit. The addition of RL1 + RL2, leads to an off-set between measured temperature and real temperature. This connection must be avoided.

• 3-wire connection

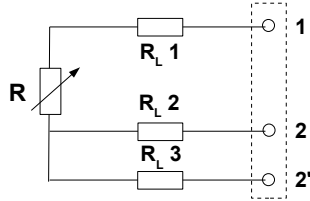

This connection involves identical line resistors (RL1-RL2-RL3), RL2 + RL3 allow you to measure the line resistance that will be subtracted from the measured resistance between 1 and 22' terminals. This is the most common connection.

• 4-wire connection

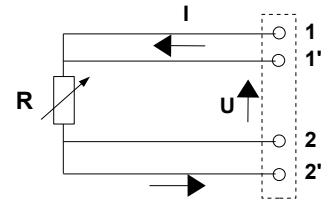

Regulated current is going through 11' and 22' terminals and the measurement is made at the sensor terminals, so none of the line resistors are taken into account. This is the most accurate connection.

Tolerance of PT100 and PT1000 probes.

Norms as per IEC 751 (1993), BS 1904 (1984) and DIN 43760 (1980).

Temp °C	Tolerances					
	Class B		Class A		1/3 DIN	
	± °C	± Ohms	± °C	± Ohms	± °C	± Ohms
-100	0,8	0,32	0,35	0,14	0,27	0,11
-50	0,55	0,22	0,25	0,1	0,19	0,08
0	0,3	0,12	0,15	0,06	0,1	0,04
100	0,8	0,3	0,35	0,13	0,27	0,1
200	1,3	0,48	0,55	0,2	0,44	0,16
300	1,8	0,64	0,75	0,27	0,6	0,21
400	2,3	0,79	0,95	0,33	0,77	0,26

Resistance values for PT1000 (Ω) must be multiplied by 10 for the same corresponding temperature value (°C). I.e : at 0°C for Class B PT1000 ± 0.3°C → ± 1.2 Ω

Tolerances of NTC probes

Measuring range °C	Tolerances °C
from -20°C to 0°C	± 0.5°C
from 0°C to +70°C	± 0.2 °C
from +70°C to +100°C	± 0.5 °C

Accessories (See Datasheet)

- Transmitter output 4/20 mA or 0/10V
- Wall fixing support
- Stainless steel mounting brackets
- ¼" or ½" Gas screw nut
- Stainless steel compression fitting
- Teflon or stainless steel ferrule for compression fittings

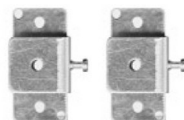

- Sleeve to weld for food industry
- Stainless steel union fitting
- ½" Gas or NPT thread cuff
- Thermo-conducting silicone grease
- Calibration certificate
- Thermowell



www.kimo.fr

EXPORT DEPARTMENT

Tel : + 33. 1. 60. 06. 69. 25 - Fax : + 33. 1. 60. 06. 69. 29

e-mail : export@kimo.fr



Distributed by :